







**CL.1 Deck valve clockwise closing cold - Brushed Platinum**

CL.1

20 000 705

- hole diameter valve 32 mm
- rosette 60 x 60 mm
- with cold marking



	Brushed Platinum	20 000 705-06
	Chrome	20 000 705-00
	Dark Chrome	20 000 705-19
	Brushed Champagne (22kt Gold)	20 000 705-46
	Champagne (22kt Gold)	20 000 705-47
	Brushed Dark Platinum	20 000 705-99

20 000 705

mm [inches]

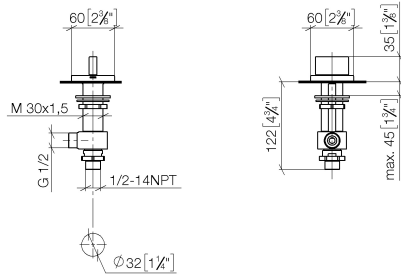

Flow rate chart



Certificates

IAPMO\_4976 (5). WRAS\_2103001. LGA\_28688.

20 000 705

Parts for other finishes can be found here: [Chrome](#)

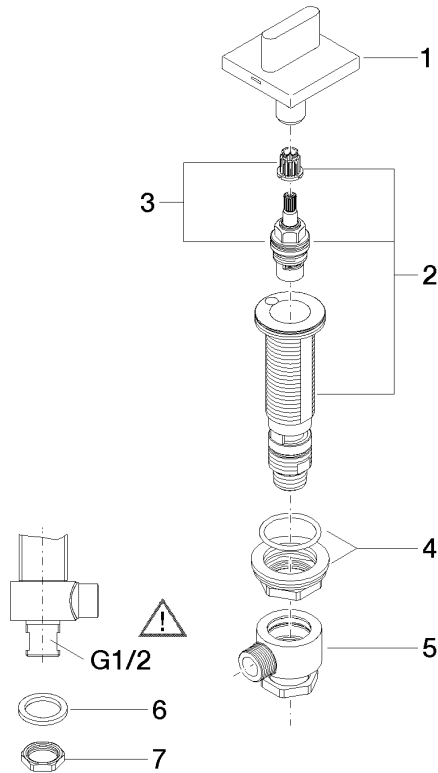

### Spare parts list

No.	Item Number	Name	Quantity used	Delivery time
1	90 20 70 051 04-06	handle ( cold )	1	10
2	04 17 11 058 33 90	side panel	1	2
3	90 90 03 133 00 90	top	1	2
4	04 23 10 032 78 90	fixing set	1	2
5	04 17 11 023 10 90	distributor	1	2
6	90 23 30 040 00-06	threaded connector	1	10
7	09 30 11 059 90	disc	1	2
8	09 23 10 012 90	nut	1	2